

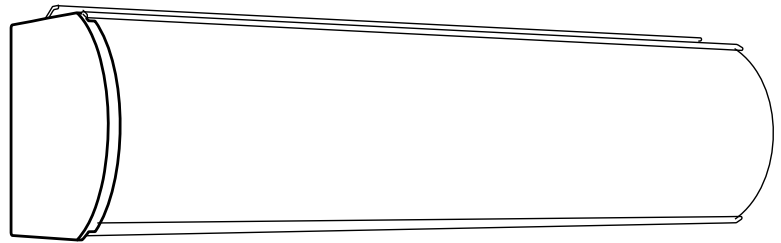

Transitional Shades



Large Cassette

Installation Instructions

Thank You

Thank you for choosing your Allure Transitional Shade
With proper installation and care, your new shades will provide many years of beauty and performance.

Before Installing

Remove shade from the package. Keep all packaging until shade operates to your satisfaction. Contents of your hardware package may vary depending on options chosen.
Additional fasteners may be needed on your specific mounting surface (not included).

Tools Needed

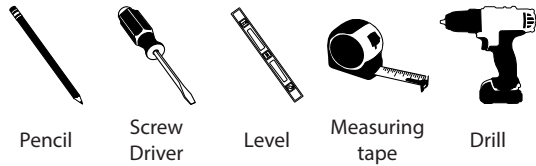

Shade Width	Brackets Required	2-on-1 Headrail
15" - 48"	2	If installing a 2-on-1 headrail: one bracket is required to be located at the Center Gap
48 1/16" - 72"	3	
72 1/16" - 90"	4	
90 1/16" - 120"	5	
120 1/16" - 156"	6	

Step 1

Space Brackets in Window

Measure 2" in from each end of the headrail and mark the bracket location on the mounting surface.

Space additional brackets evenly between the end brackets and mark the bracket location on the mounting surface

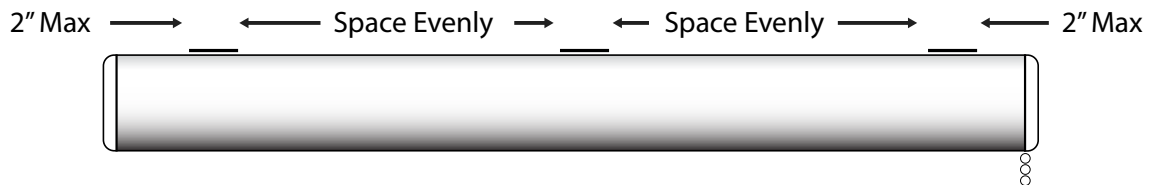

Note: install brackets into studs or headers when possible, and space evenly



If spacer blocks are being used, place in between mounting surface and bracket before attaching with screws

IMPORTANT: Brackets need to be Level and Aligned
Shimming Brackets may be required

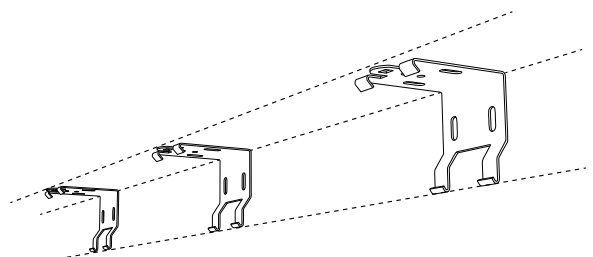

Step 2 Install the Brackets

Make sure the side marked Top is Up

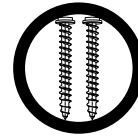
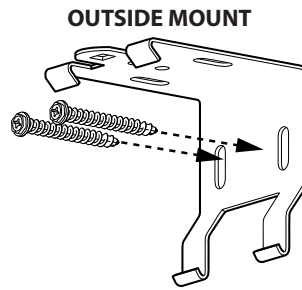
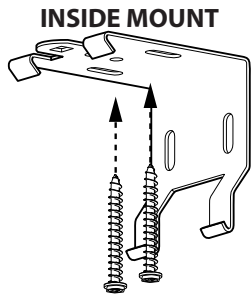

IMPORTANT: Two screws are needed to attach each installation bracket

Use two screws to secure to the mounting surface

Step 3 Install the Shade

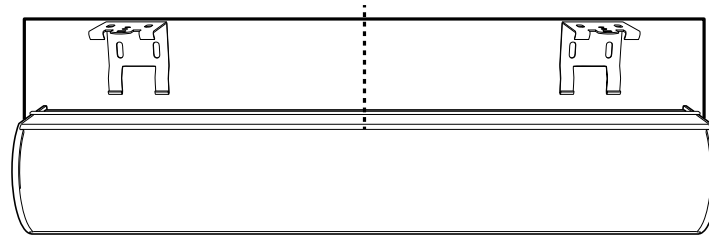

Center Shade with Window Opening

Tilt the front of the headrail Down

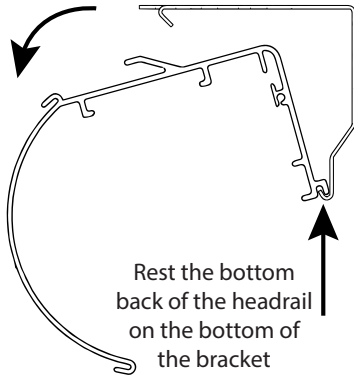

Rest the bottom back of the headrail on the bottom of the bracket

Rotate the front of the headrail from the front back into the bracket

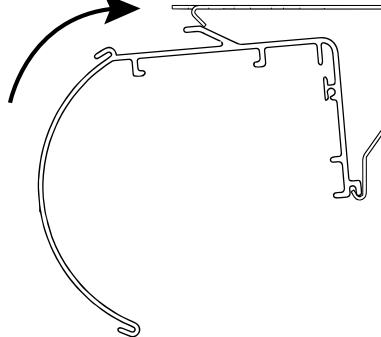

Rotate the headrail until it snaps into place on the bracket

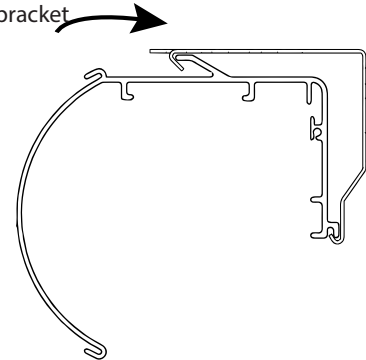

Step 4 Operate the Shade

Clutch

Pull gently on the back side of the chain to lower it.

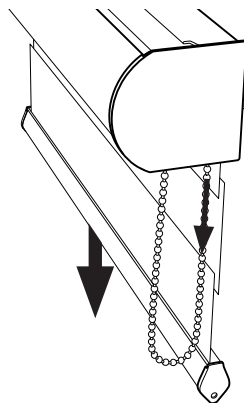

Pull gently on the front side of the chain to raise it.

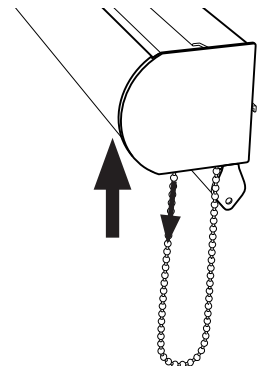

Accu-Rise

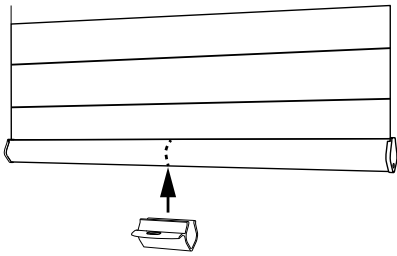

Find the Center of your Bottom Rail

Snap the Handle onto the rail in the center position

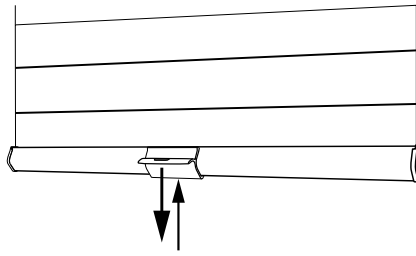

Pull Accu-Rise shade gently from the Handle to lower it.

Push up from center to raise it.

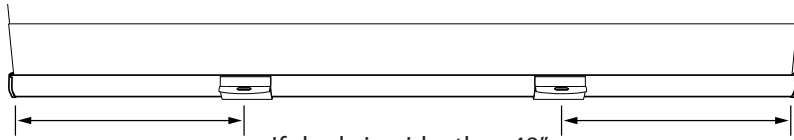

If shade is wider than 48"
Use 2 handles spaced evenly from each end and operate with both hands

Troubleshooting:

If shade doesn't raise, the roller may be binding on the internal brackets.

Remove End Caps and gently pry the internal bracket away from the roller so that it moves freely

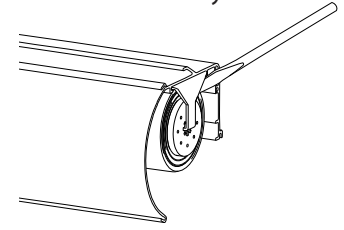

Step 5 Install Cord Tensioners

Cord Tension Lock

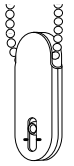

Installers MUST INSTALL Cord Tension Lock Properly

Mark Mounting Position

Lower shade to make sure the Cord Tension Lock is not placed in the path of the bottom rail or fabric

Outside Mount

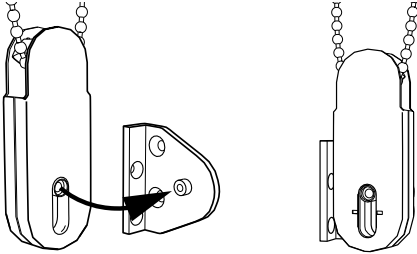

Inside Mount

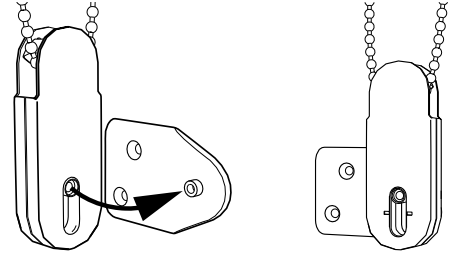

Insert the nub of the Bracket into the Tensioner Center Hole

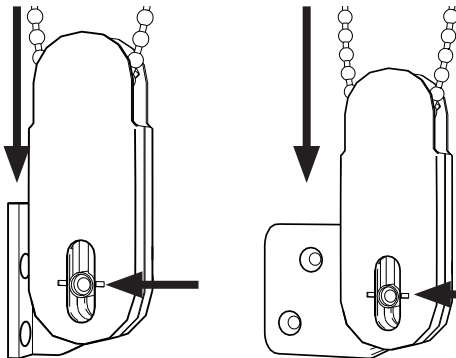

Pull the Chain taut with the Bracket on the mounting surface

Slide the Bracket and the Tensioner Center down to the Guide Lines on the Cord Tensioner

The Center Hole of the Tensioner must be aligned with the guide lines

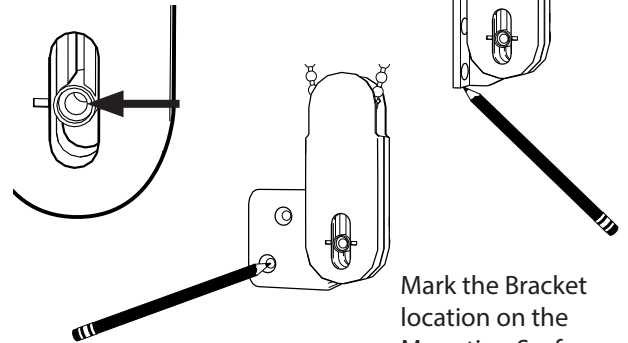

Mark the Bracket location on the Mounting Surface

While holding the lock firmly in place, check that the loop can move freely through the Tensioner

If the Bracket is not Aligned properly:

If the Tensioner locks onto the loop, it is too loose and the bracket and lock should be **moved down**

If the loop does not run freely through the lock, it is too tight and the bracket and lock should be **moved up**

Step 5 Install Cord Tensioners (continued)

Attach the Bracket to Mounting Surface

Outside Mount

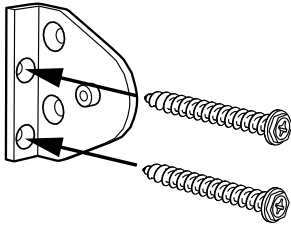

Move Tensioner out of the way and attach to Mounting Surface with the Two Longer Screws provided

Inside Mount

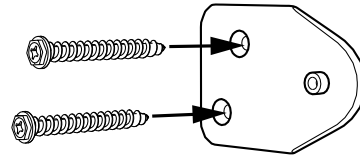

Attach the Cord Tension Lock to Bracket

Pull the Tensioner's spring loaded Slider down to the bracket

a small tool may be helpful in moving the slider

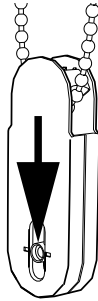

Make sure the Tensioner's Center Hole is seated on the nub of the bracket

Use the small screw to attach Tensioner

Do not Overtighten

Outside Mount

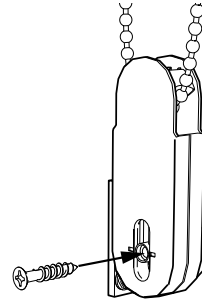

Inside Mount

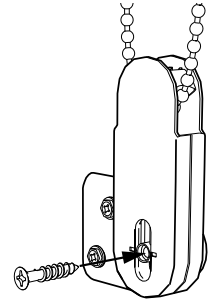

IMPORTANT: the Tension Lock must be properly installed and secured

Step 6 Install Hold Down Magnetic (standard)

Remove Film from Magnet strips and attach to Top and Bottom of the Rail

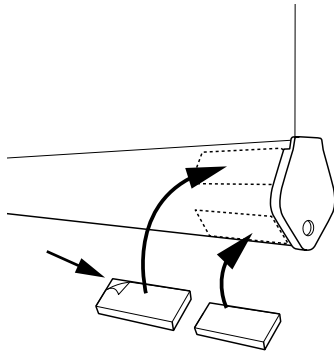

Determine the orientation of the Hold Down Bracket

Lower the shade to the closed position and mark the Bracket location where it attaches to the TOP of the Rail

This allows the shade to be opened while still attached to the bracket

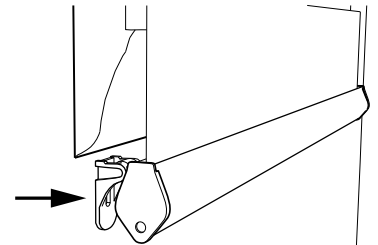
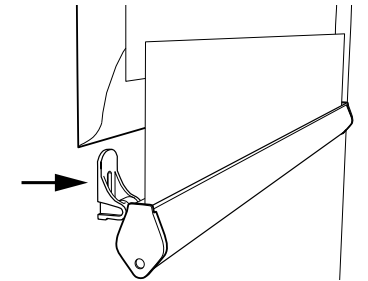

Secure HoldDown to the wall

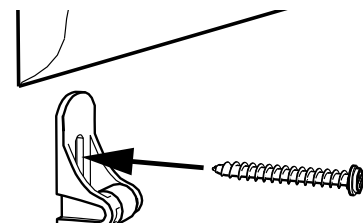
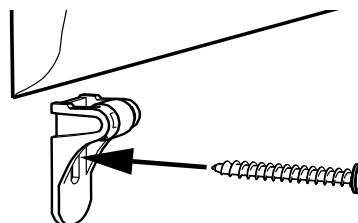

Step 6 Install Hold Down (optional)

This Hold Down Option does not allow you to freely open and close the shade

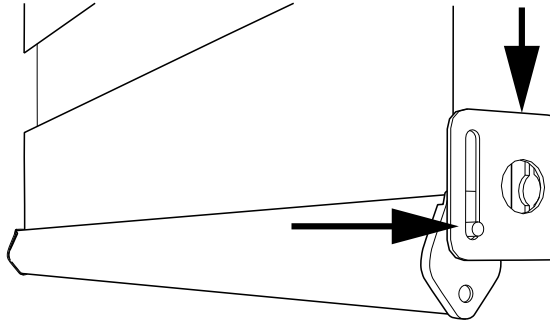

Lower the shade to the closed position

line up the Hold Down bracket where the pin on the Rail is at the bottom of the slot

This allows the shade to be opened while still in the bracket

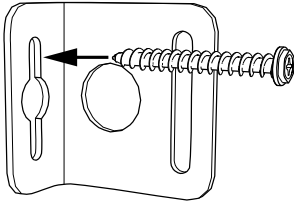

Attach Bracket to mounting Surface

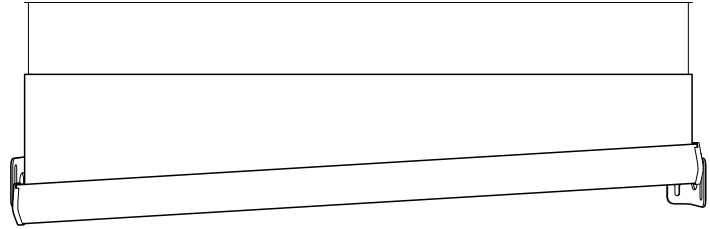

Rotate the bottom rail to get the pins into the brackets

Shade Removal

Using Direct Force push the headrail into the bracket

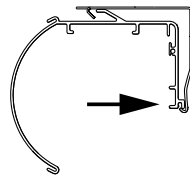
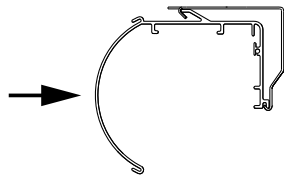

Apply force until the bracket is pushed back far enough to clear the tabs on top of the headrail

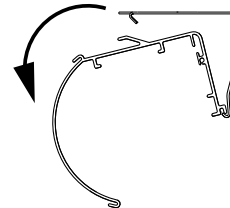

Rotate the Headrail forward out of the bracket to remove