

allure® Transitional Shades



Tools Needed

Modernaire Installation Instructions

Thank you for choosing Allure Transitional Shades. With proper installation and care, your new shades will provide many years of beauty and performance.

Variations are the appeal of Allure...

The exclusive processes used in weaving these materials create distinctive variations and you may see various threads or slubs woven into the fabric creating light or dark colors intermittently dispersed throughout. These variations are intentional and add to the beauty and truly unique appearance of each shade.

#6 Hex Head
Provided



Wall Anchors
Not Provided



Sheet Metal
Not Provided



Fasteners

BEFORE INSTALLING

Remove shade from the package. Keep all packaging until the shade operates to your satisfaction. Contents of your hardware package may vary depending on options chosen. Additional fasteners may be needed based on your specific mounting surface.

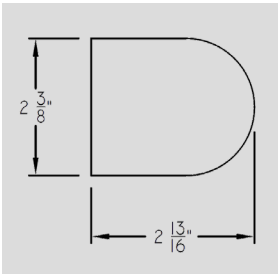

Modernaire

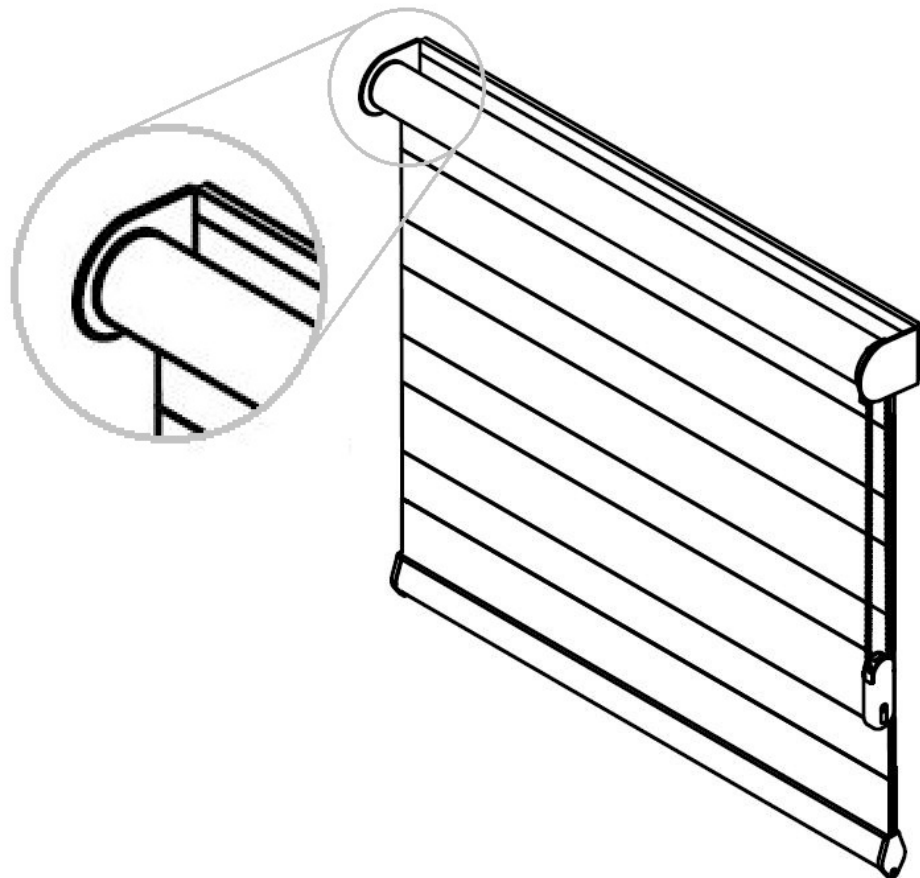

allure[®] Transitional Shades

Installation Instructions

Brackets Required		
Shade Width	15" - 48"	2
	48 1/16" - 72"	3
	72 1/16" - 90"	4
	90 1/16" - 120"	5
	120 1/16" - 156"	6

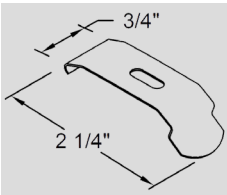

Modernaire Bracket

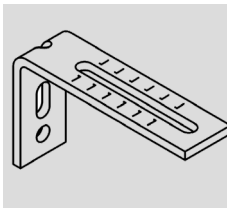

2 3/4" Projection Bracket
OR
3 5/8" Projection Bracket

INSTALL THE BRACKETS

Inside Mount

Mount using the top bracket hole. Make sure the release tab is always mounted to the back.

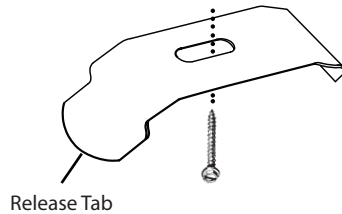

INSTALL THE BRACKETS

Outside Mount

Measure 2" in from each end of the headrail and mark the bracket location on the mounting surface. Space additional brackets evenly between the end brackets.

Mount first bracket by putting a screw into the slotted hole of the bracket. Make sure the release tab is always mounted to the bottom. Repeat process on the other side. If center support is needed, evenly space it between the left and right bracket. Brackets must be level to ensure proper operation.

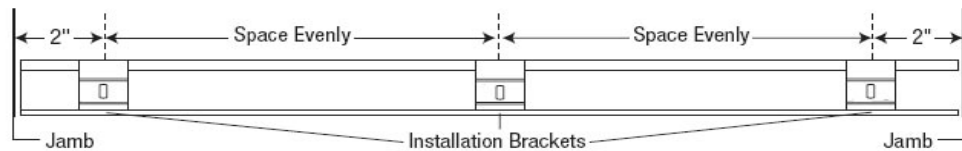
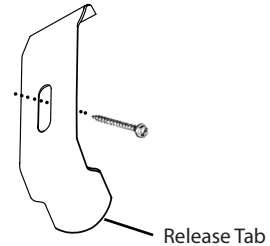

Step 1

INSTALL THE SHADE

Inside Mount

Hook the front channel of the headrail to the front of the bracket. Press firmly up on back of shade to snap in.

Operate the shade for proper operation and adjust if necessary.

INSTALL THE SHADE

Outside Mount

Hook the top channel of the headrail to the top of the bracket. Press shade firmly back to snap in.

Operate the shade for proper operation and adjust if necessary.

Step 2

allure[®] Transitional Shades

Installation Instructions

ADJUST THE SHADE (if necessary)

Any product that rolls on a tube or roller has a potential to skew. All shades are checked for skewing at the time of inspection. The factory will shim the roller if necessary to assure your shades are rolling straight. When installing, make sure the brackets are level. If the brackets are off by even as little as $\frac{1}{8}$ " , skewing can occur.

If shade veers toward the right, lower completely and place a 4" strip of masking tape on the roller on the left side. Repeat as necessary until a straight roll is achieved. (Fig. A)

If shade veers toward the left, lower completely and place a 4" strip of masking tape on the roller on the right side. Repeat as necessary until a straight roll is achieved. (Fig. B)

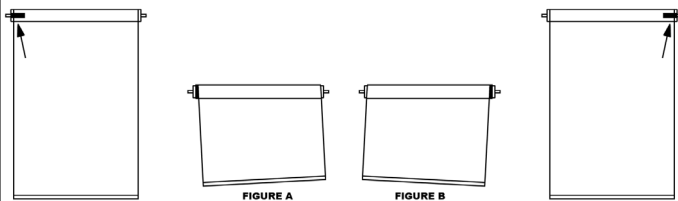

Step 3

ADJUSTING THE LOWER STOP

Inside/Outside Mount - Right Control

1. Measure how much shade needs to be raised or lowered. (IB)
2. Remove shade from window opening. (IB)
3. Remove cassette cover opposite of clutch (idle end of the shade)
4. Lower shade to original lower limit.
5. Pull slightly on chain to create slack in clutch.
6. Insert large flat blade screwdriver into end of shade.
7. Turn clockwise to raise shade or counter clockwise to lower shade.
8. Pull on chain to make sure desired length is correct. If not, repeat steps 5 - 7.
9. Reattach cassette cover (and return shade to window opening if (IB).

Inside/Outside Mount - Left Control

Follow steps 1 - 6 above.

7. Turn counter clockwise to raise shade or clockwise to lower shade.
8. Reattach cassette cover (and return shade to window opening if (IB).

Step 4

INSTALL CORD TENSION LOCK

See Cord Tension Lock installation Instructions

INSTALL HOLD-DOWNS (Optional)

See Hold-Down Installation instructions

Step 5

CARE AND CLEANING

Allure Transitional Shades have an extraordinary and remarkable self-dusting feature. Simply roll the shade up into the headrail and back down again to remove dust. The shading can be feather dusted or vacuumed at a low setting. Spots can be cleaned with a damp sponge and mild soap. To avoid discoloration, do not use chemical cleaners. Ultrasonic cleaning is not recommended. It will damage the shade.

Note: In dry conditions, static may occur causing front and back panels to stick together or fabric to wave.

If this happens, please spray with anti-static guard. This may have to be done periodically to eliminate static buildup.

Recommended brand is "Static Guard".

Step 6