

heartland woods®

fidelis®

wonderwood®

FIXED SLAT SPECIALTIES INSTALLATION INSTRUCTIONS

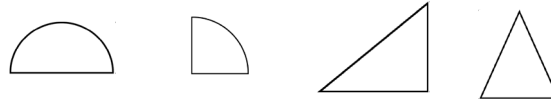



Thank you for choosing a fixed slat specialty blind. With proper installation and care, your new blind will provide many years of beauty and performance.

Tools and Fasteners Needed

- Power Drill, 1/4" Driver and drill bits
- Tape Measure
- Flat blade Screwdriver
- Phillips Screwdriver
- Pencil
- Level

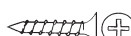

Mounting Surface	Fastener
Wood	#6 Hex Head Provided 
Drywall, Plaster	Wall Anchors Not Provided 
Metal	Sheet Metal Not Provided 

Begin

Keep all packaging until the blind is completely installed. Open each package and make sure you have the following components for each window.

- The required number of slats, cut to varying widths to form the correct shape.
- Two or more uprights into which the slats are inserted.
- One bottom rail to which the uprights are attached, along with two flat head screws per upright to attach the uprights to the bottom rail: and one extra slat for light control. Circle, Oval, Hexagon and Octagon will not use a rail.
- Mounting brackets
- Two screws per mounting bracket
- One snap button per mounting bracket

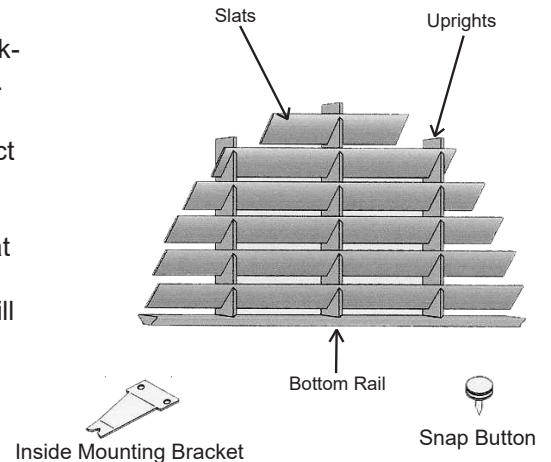

Assemble Blinds with Bottom Rails

Arch, Quarter Circle, Angle and Triangle

Position the Bottom Rail

- Stand the bottom rail on its back edge, with its front edges facing up and the countersunk holes toward you.
- Labels indicating the position of the uprights are located on the top of the bottom rail, near its front edge.

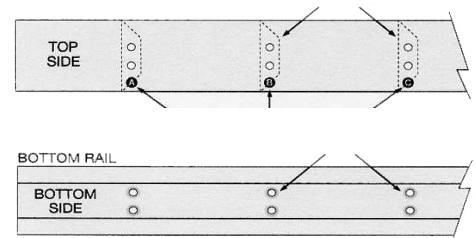

Arrange the Uprights

- Each upright is marked with a label that matches the label on the bottom rail.
- Arrange the uprights as labeled against the top side of the bottom rail.
- The slots in the uprights must face up, and the end of the upright with the two holes goes against the bottom rail.

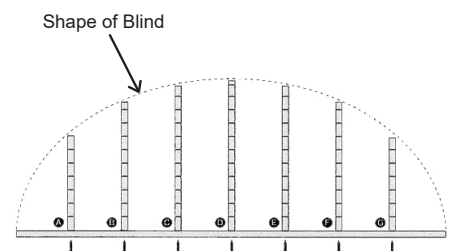

Attach the Uprights to the Bottom Rail

- Attach the uprights to the bottom rail using two flat head screws (#6 x 1/1/4") per upright.
- The screws go through the countersunk holes in the bottom rail, and then into the uprights.
- Double check that the slots in all the uprights are facing up. Do not over-tighten the screws.

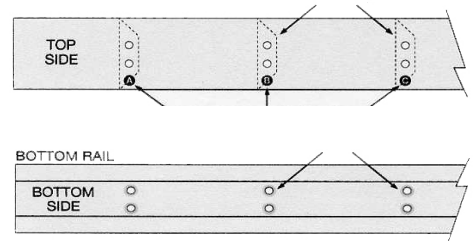

Install the Slats

- Insert the slats into the slots in the uprights. Start at the bottom and insert the longest slat.
- Work your way up to the top until all slots are filled.

Assemble Blinds with No Bottom Rails

Hexagon, Octagon, Circle and Oval

Arrange the Uprights

Each upright is marked with a label: A, B, C, etc. Start on the left side with "A" and arrange the uprights as labeled.

- Stand the uprights on their back edge so that the slots are facing up, with the slots angled the same on all uprights.
- Arrange the uprights so that they approximate the shape of the blind, with the slots aligned horizontally.
- The distance between the slots should be approximately equal.

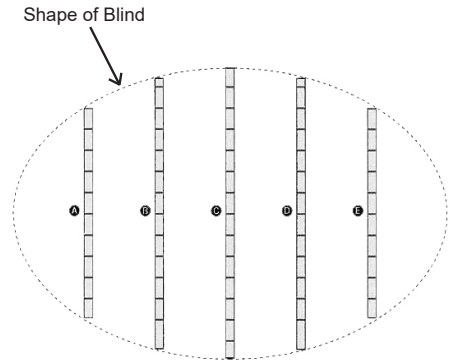

Install the Slats

- Slats are stacked in the order of assembly. The first slat is the Bottom Light Stop used to eliminate the light gap at the bottom rail. (See next step)
- Start at the bottom slot of the uprights and insert the first slat.
- Work your way up to the top until all slots are filled.

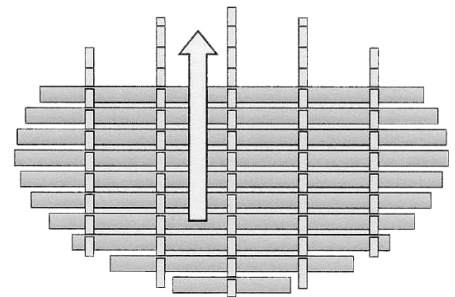

Bottom Light Stop Installation

Arch, Quarter Arch, Angle and Triangle

An additional slat labeled "Bottom Light Stop" is included with your order. This slat is the same length as the bottom rail. It is designed to help eliminate the light gap at the bottom of the specialty shape. If you choose to install this extra slat:

- Use the velcro provided to attach the slat to the rear side of the bottom rail, with the slat upright as shown.
- Be sure the slat is installed on the rear side of the bottom rail so it faces the window when the blind is installed.

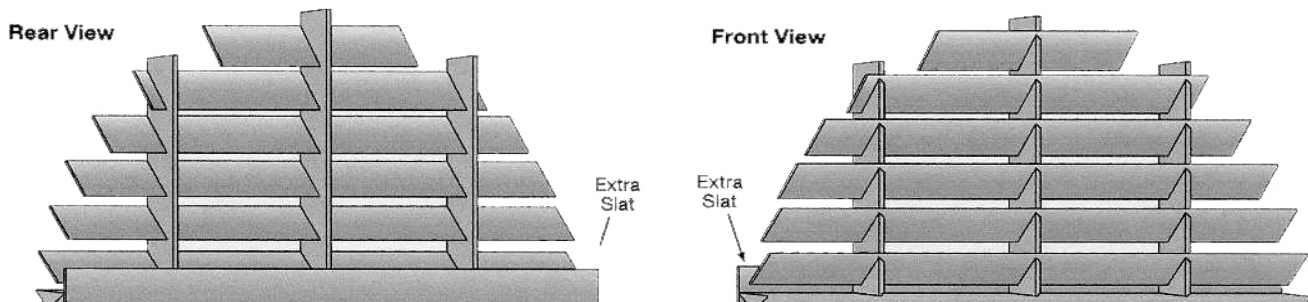

Install the Blind

Snap Buttons

- Snap buttons are installed onto the top of the uprights.
- On blinds with no bottom rail, snap buttons are installed onto the bottom of the uprights as well.
- On outside mounted blinds with a bottom rail, snap buttons are also installed onto the ends of the rail.

The chart shows onto which uprights you will need to install the snap buttons. The black boxes indicate snap button locations.

NUMBER OF UPRIGHTS

■ Snap Button Locations

2:	A	B					
3:	A	B	C				
4:	A	B	C	D			
5:	A	B	C	D	E		
6:	A	B	C	D	E	F	
7:	A	B	C	D	E	F	G

UPRIGHT LABEL DESIGNATIONS

Install the Snap Buttons

- Insert snap buttons into the pre-drilled holes on the uprights indicated on the chart, and press them firmly into place.
- On blinds with no bottom rail, remember to install snap buttons on both the top and bottom of the uprights.

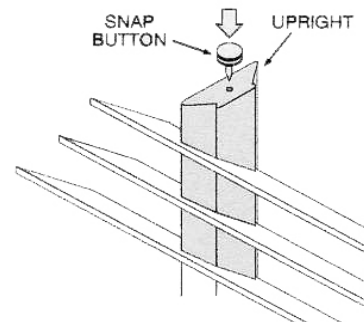

Install the Mounting Brackets

Mark the Mounting Bracket Locations

- With inside mount specialty shapes, hold the blind inside the opening, flush with the front of the opening, and mark on the casement the location of the front edges of all snap buttons.

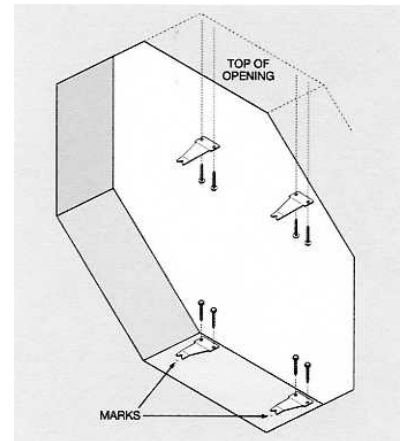

Attach the Mounting Brackets (Inside Mount)

- Position the circular opening at the front of the brackets approximately 1/4" behind where you marked the front edge location of the snap buttons.
- Mark where to drill pilot holes for the #6 x 1 1/4" mounting screws.
- Drill 1/8" pilot holes and attach the brackets with the screws.
- Be sure all brackets are mounted the same depth inside the opening.

Install the Blind

- Align the snap buttons on the uprights (and bottom rail, if applicable) with the front of the mounting brackets.
- Insert the snap buttons into the mounting brackets until they “snap” in place.

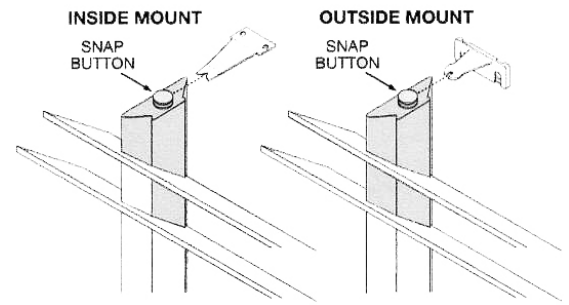

Care and Cleaning

Wood Blinds should be dusted regularly. Use a soft clean cloth, chemically treated dust cloth or dusting mitten. Blinds may also be vacuumed using the brush attachment. Painted slats may be wiped clean with a soft, damp cloth. Stained blinds should be treated periodically with a wood preservative to protect the finish and enhance the luster. Faux wood blinds should be washed with a non-abrasive mild detergent solution. Allow to air dry. Do not ultrasonically clean wood or faux wood blinds.



www.lafayetteinteriorfashions.com