

Installation Instructions

3" and 4" Fascia

Thank You

Thank you for choosing Genesis Custom Window Shades.
With proper installation and care, your new shades will provide many years of beauty and performance.

Before Installing

Remove shade from the package. Keep all packaging until shade operates to your satisfaction. Contents of your hardware package may vary depending on options chosen. Additional fasteners may be needed on your specific mounting surface.

Tools

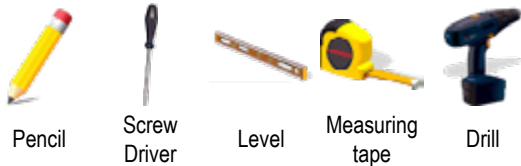

Fasteners

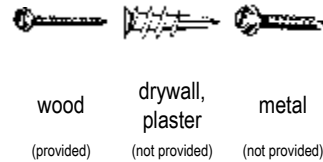

Your Shade

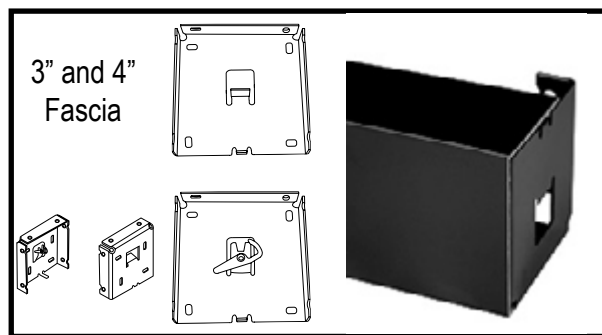

Step 1 Install Brackets

The Open End of each bracket faces Downward, as shown below.
Use at least two screws per bracket, and make sure screw heads clear the clutch.

Outside Mount

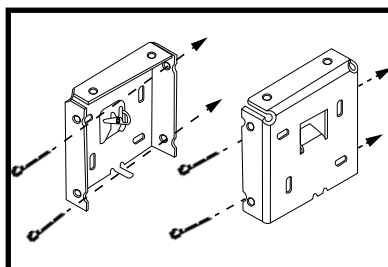

Inside Mount

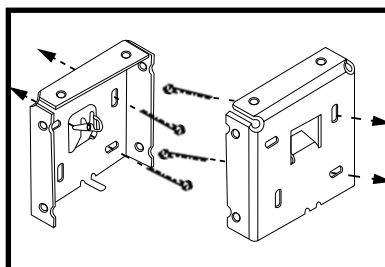

Ceiling Mount

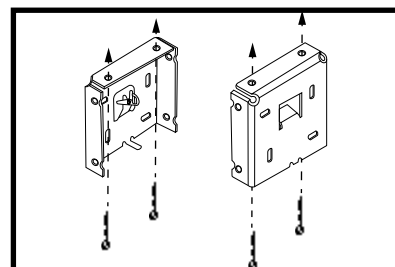

Make sure Brackets are mounted Level or the shade will not roll straight.

Step 2

Install the Shade

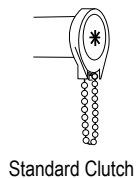

Step 1

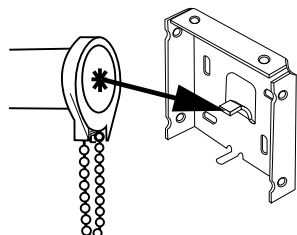

Push the clutch end of the shade straight onto the bracket with a tab

Step 2

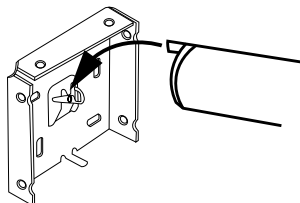

Lower the other end of the shade onto the "V" of the bracket. Make sure it is seated properly

Step 3



With the shade seated in place turn the retainer arm to lock it securely

Step 3

Operate the Shade

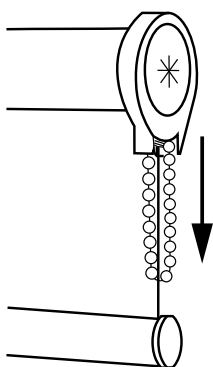

Pull gently on the back side of the chain to to lower it.

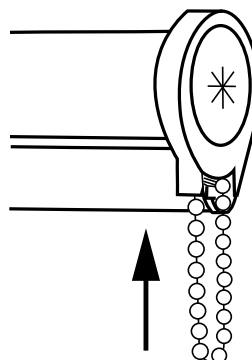

Pull gently on the front side of the chain to to raise it.

Check Shade for proper operation. If shade Skews left or right (does not roll up straight), check that the brackets are level. If brackets are level and the shade still skews, it may require shimming.

Shimming

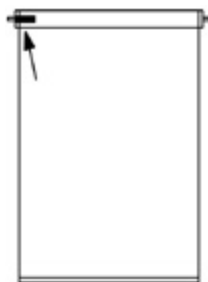

If shade veers toward the right (Fig. A) lower the shade completely and place a 4" strip of masking tape on the roller on the left side. Repeat as necessary until a straight roll is achieved.



If shade veers toward the left (Fig. B) lower the shade completely and place a 4" strip of masking tape on the roller on the right side. Repeat as necessary until a straight roll is achieved.

Step 4

Install Cord Tensioner, Hold Down, Chain Stop

Cord Tension Lock

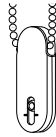

See Cord Tension Lock installation instructions

Hold Downs



See Hold-Down installation instructions

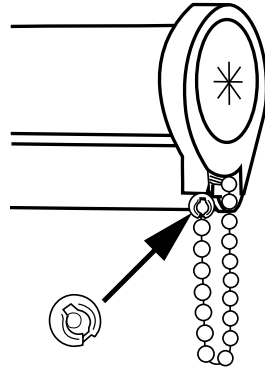

Lower Shade to desired length.

On the front of the chain directly below the clutch, attach the round stop to the first bead on the chain.

This will prevent the shade from being lowered beyond the desired length.

After the shade is installed and operates correctly, proceed to install the fascia

Step 5

Install the Fascia

Step 1

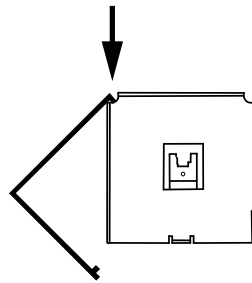

Tilt fascia so that the lip at the top of the fascia can rest into the slots in the top of the bracket

Step 2

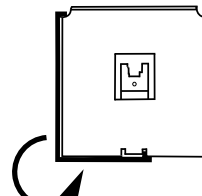

Tilt the fascia forward until it snaps onto the bottom bracket tabs

Step 6

Install the Bracket Covers

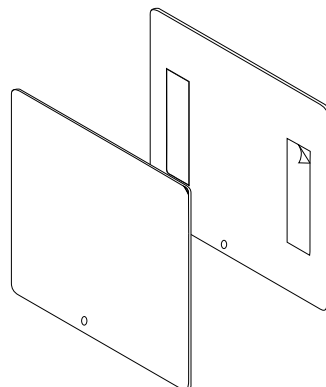

Outside Mount

Peel off the paper and affix the metal bracket cover to the fascia end