

## Installation Instructions

### Board Mounted Panel Track

### Thank You

Thank you for choosing Genesis Custom Window Shades. With proper installation and care, your new shades will provide many years of beauty and performance.

### Before Installing

Remove shade from the package. Keep all packaging until shade operates to your satisfaction. Contents of your hardware package may vary depending on options chosen. Additional fasteners may be needed on your specific mounting surface.

#### Tools

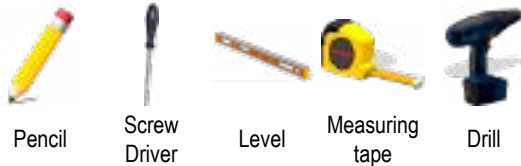

#### Fasteners

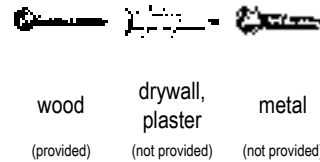

### Your Product

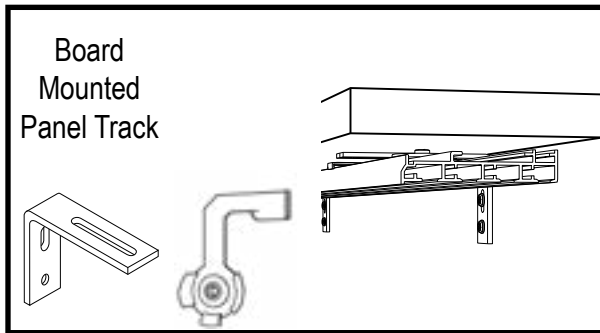

| Shade Width      | Brackets Required |
|------------------|-------------------|
| Up to - 36"      | 2                 |
| 36 1/16" - 72"   | 3                 |
| 72 1/16" - 104"  | 4                 |
| 104 1/16" - 130" | 5                 |
| 130 1/16" - 144" | 6                 |
| 144 1/16" - 182" | 7                 |
| 182 1/16" - 192" | 8                 |

### Step 1 Mark Bracket Location

**Inside Mount** installations: no brackets are necessary. 3" screws are provided to secure shade directly to window opening, but they should still be spaced evenly across the board

**Outside Mount** installations: brackets are necessary. 1 1/2" screws are provided to secure the bracket to the wall and 3/4" screws are provided to secure the bracket to the board

Start brackets 5" in from each end and mark bracket locations on mounting surface while making sure not to interfere with the cam brackets

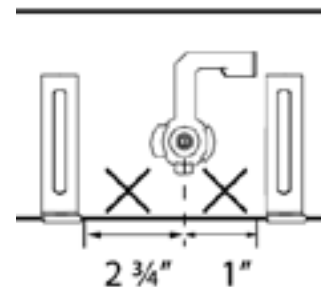
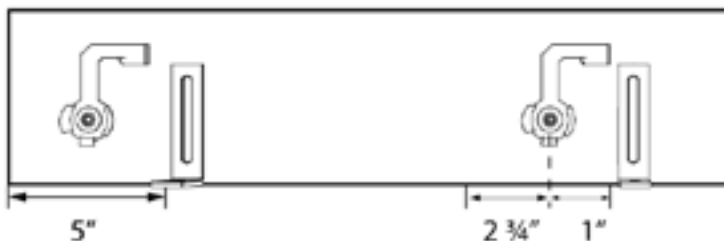

stay to the left of the center of the Cam Bracket at least 2 3/4" and to the right at least 1"

## Board Splice

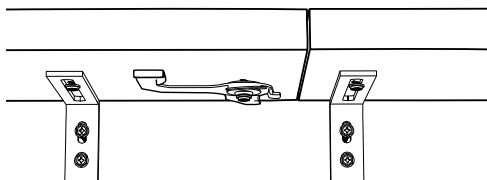

If your board is spliced, an additional bracket will be required at the splice while maintaining proper clearance from the Swivel Bracket

## Step 2 Install Brackets

Use a Level to make sure the mounting surface is level

Once bracket locations are marked on the mounting surface begin installing the brackets

### Outside Mount

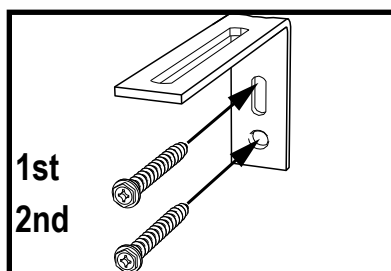

Begin installing the brackets by using the elongated hole first in case any adjustments must be made.

The brackets **must be level** to ensure proper operation of the panel track.

Once the brackets are properly aligned use the second, round hole on the bracket to secure to mounting surface

## Step 3 Install Board

### Outside Mount

Place board on top of mounted brackets and adjust shade side to side for optimal window coverage

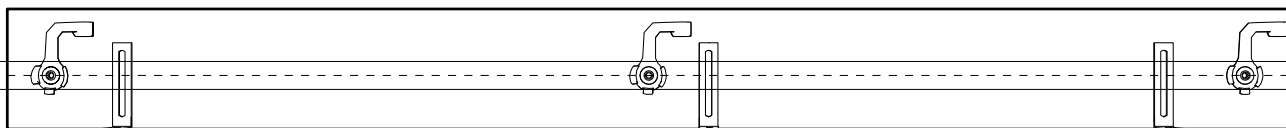

line screws up with the Cam Bracket screws in order to ensure proper operation

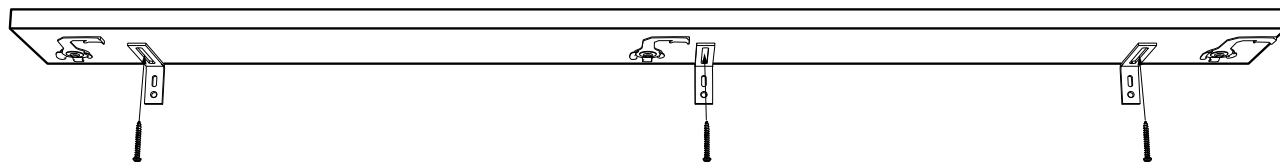

Place screw up from the bottom of the board and into the slotted channel on bracket

### Inside Mount

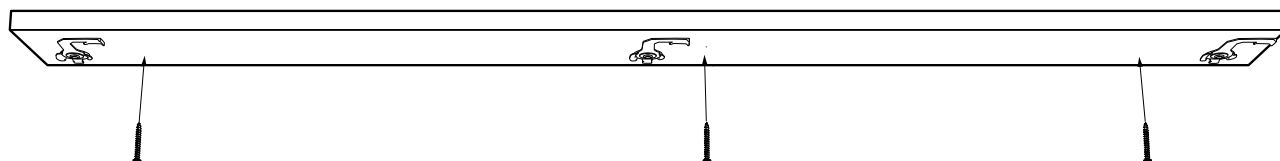

Space screws maintaining clearance for Cam Brackets and line up with the center of their screws

Pre-drill with a 1/8" drill bit. Run screws vertically through board into mounting surface

## Step 4 Install Track

### Splice Track (if needed)

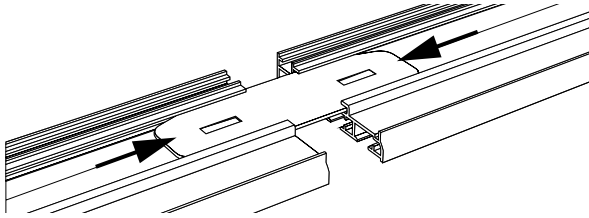

Insert splice into the top channel of the track and make sure the raised wedges are pointing down and that the tracks meet as closely to the center of the splice as possible or the splice will be loose

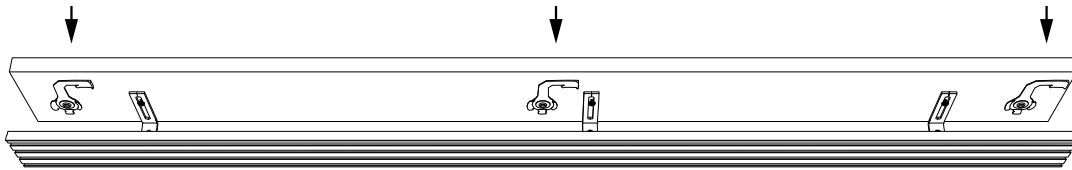

Make sure the cam brackets are all in the open position

Start in the center and move outwards

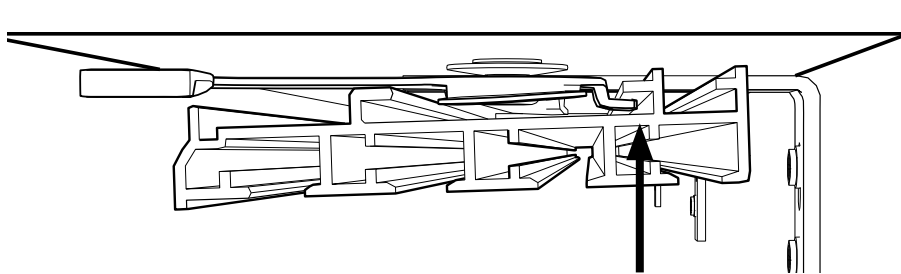

Rest track on the back of the Cam Bracket before closing brackets

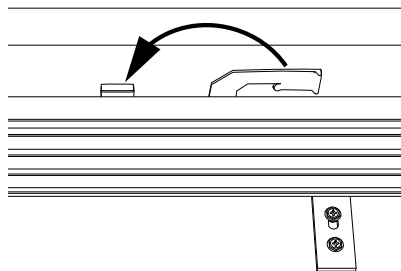

rotate Cam Bracket arm counter-clockwise until fully seated against track to lock track in place

## Step 5 Install Panels

### Step 1

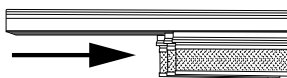

Slide all Panel Carriers to one side to ease installation

### Step 2

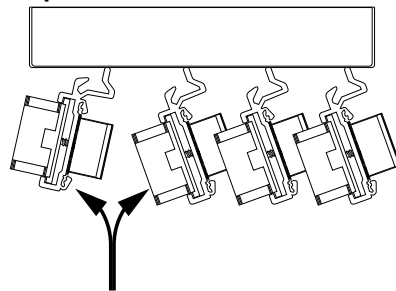

Separate the Carriers by pushing back on one and forwards on the rest to clear the Carrier's catches

### Step 3

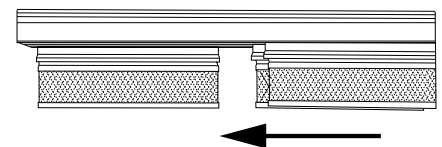

With the Panel Carrier isolated begin to install panels

### Step 4

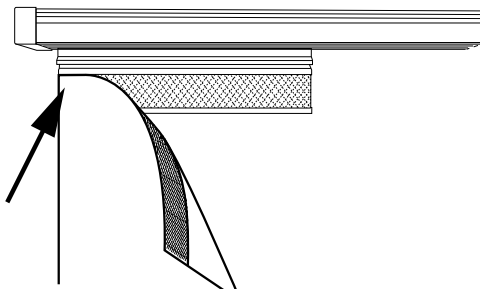

Start with one corner of the panel and line up with the Carrier's corner

### Step 5

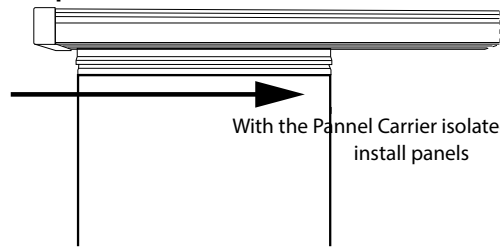

Press down on the Panel all the way across and ensure it lines up level with the Carrier

Repeat steps for each panel and then reverse steps to return Carriers to original position for proper operation

## Step 6 Install Valance

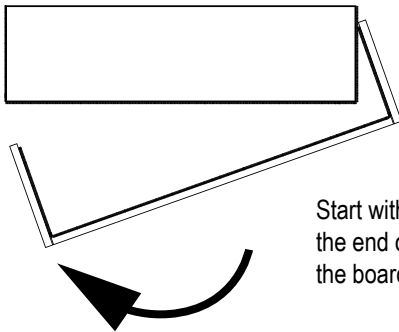

Start with one end of the Valance on the end of the board and rotate onto the board

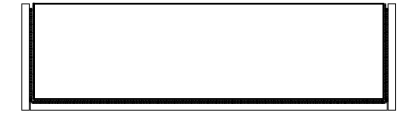

Carefully work the valance onto the board until fully seated on the velcro

### Spliced Valance

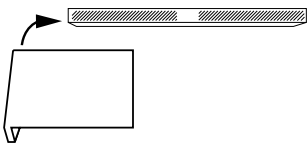

Start with one side and attach it to the velcro on the board

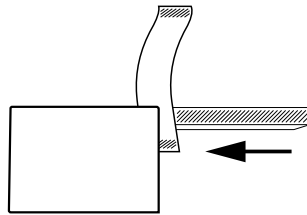

Insert and attach one end of the Fabric Keystone Splice

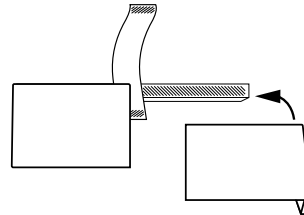

Attach the other side of the valance to velcro on board and attach velcro at splice

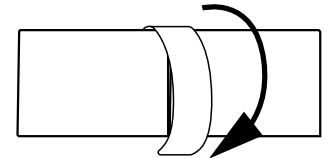

Fold over Keystone Splice and pull taut

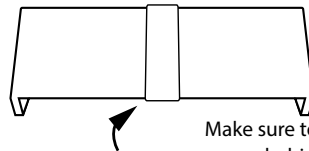

Make sure to attach to velcro behind valance

## Step 7 Wand

### Wand

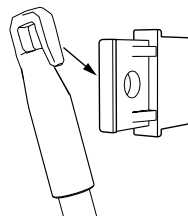

Hook the Wand into the outside front Panel Carrier