

Installation Instructions

Exterior Roller Shade with Cable Guide

Thank You

Thank you for choosing Genesis Custom Window Shades. With proper installation and care, your new shades will provide many years of beauty and performance.

Before Installing

Remove shade from the package. Keep all packaging until shade operates to your satisfaction. Contents of your hardware package may vary depending on options chosen. Additional fasteners may be needed on your specific mounting surface.

Tools



Pencil



Screw Driver



Level



Measuring tape



Drill

Fasteners



wood

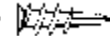

drywall,
plaster



metal

(provided)

(not provided)

(not provided)

Your Shade

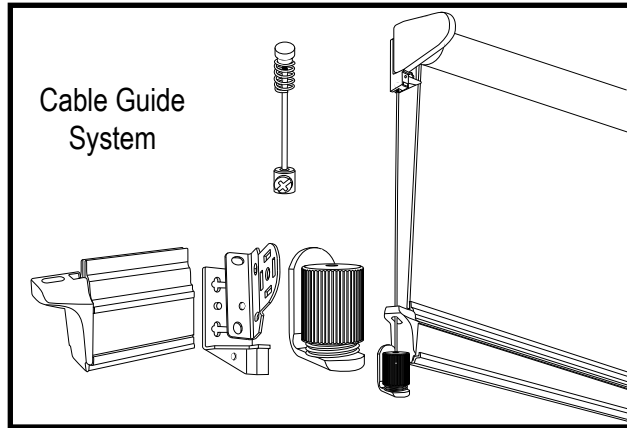

Step 1

Build the Upper Cable Support Plate

Step 1

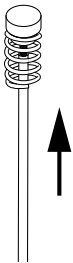

Slide the Spring up to the cable stop

Step 2

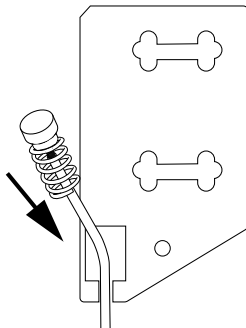

Guide the Cable through the bottom back of the Cable Support Plate

Step 3

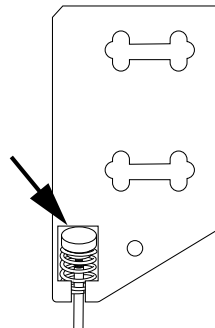

Compress the Spring and insert the Spring and Cable Stop into the Cable Support Plate Retainer Slot

Step 4

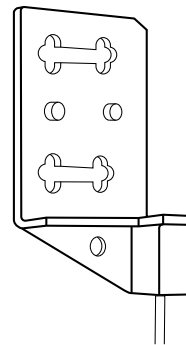

The cable should come down neatly through the bottom of the Cable Support Plate

Repeat the process for both sides of the shade

Installation Instructions

Step 2 Attach Bracket to Cable Support Plate

Step 1

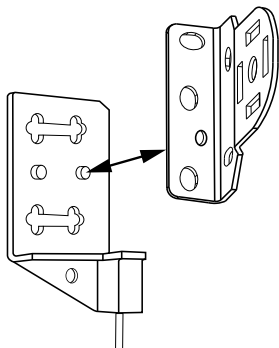

Align the Bracket with the peg on the Cable Support Plate

Step 2

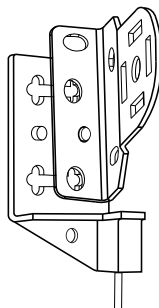

Line up the holes on the bracket so it is straight up and down

Line up outer edges at the outside of the ordered width and mark holes

Repeat the process for both sides of the shade

Step 3

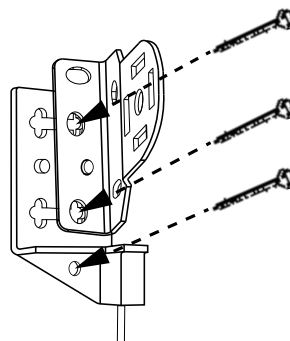

Pre-drill holes where marked and then use 3 screws to mount the Bracket and Cable Guide Assembly to mounting surface

Step 3 Install the Shade

Step 1

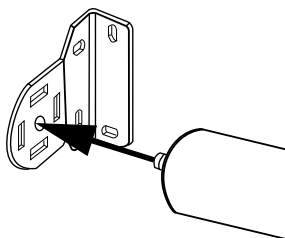

Insert the Spring Loaded Pin end into the round hole in the bracket

Step 2

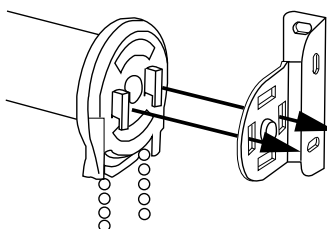

Keeping the pin end in the bracket, insert the Hook Arms on the clutch straight into the receiving slots on the bracket.

Step 3

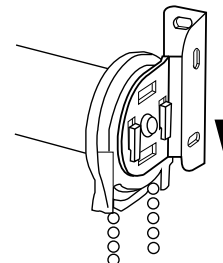

Gently push the hook arms down onto the bracket to lock them in place.

Fascia Instructions

Attach Fascia Bracket to Cable Support Plate

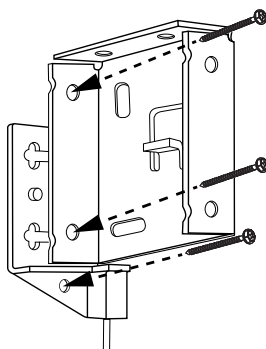

Pre-drill holes where marked and then use 3 screws to mount the Bracket and Cable Guide Assembly to mounting surface

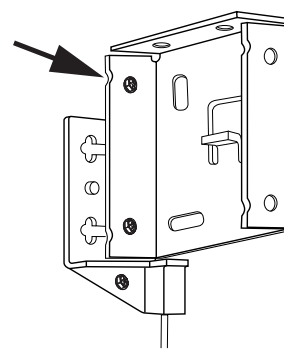

A shim is required on the top half of the Fascia Bracket to ensure that it is mounted evenly against the mounting surface

Repeat the process for both sides of the shade

Installation Instructions

Install the Shade in Fascia brackets

Step 1

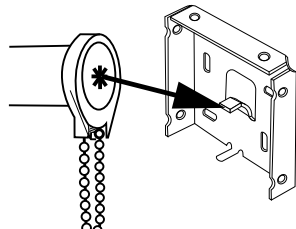

Push the clutch end of the shade straight onto the bracket with the tab

Step 2

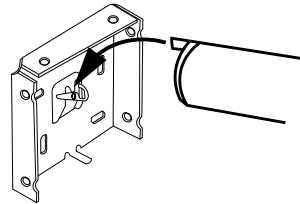

Lower the other end of the shade onto the "V" of the bracket. Make sure it is seated properly

Step 3



With the shade seated in place turn the retainer arm to lock it securely

Install the Fascia

Step 1

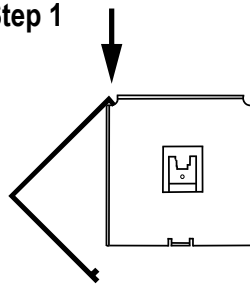

Tilt fascia so that the lip at the top of the fascia can rest into the slots in the top of the bracket

Step 2

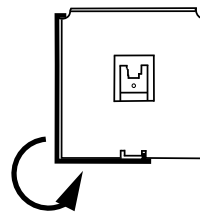

Tilt the fascia forward until it snaps onto the bottom bracket tabs

Step 4

Operate the Shade

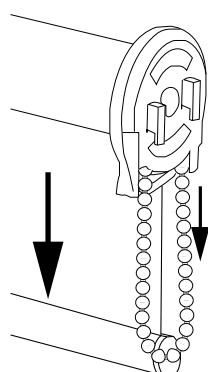

Pull gently on the back side of the chain to to lower it.

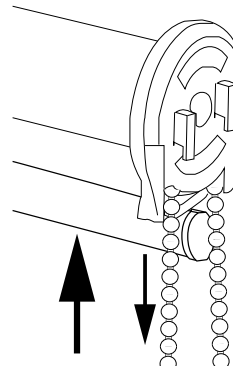

Pull gently on the front side of the chain to to raise it.

Check Shade for proper operation. If shade Skews left or right (does not roll up straight), check that the brackets are level. If brackets are level and the shade still skews, it may require shimming.

Shimming

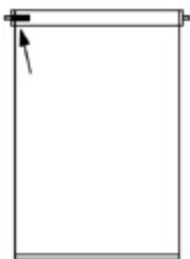
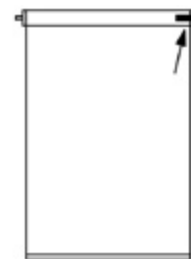

FIGURE A

If shade veers toward the right (Fig. A) lower the shade completely and place a 4" strip of masking tape on the roller on the left side. Repeat as necessary until a straight roll is achieved.

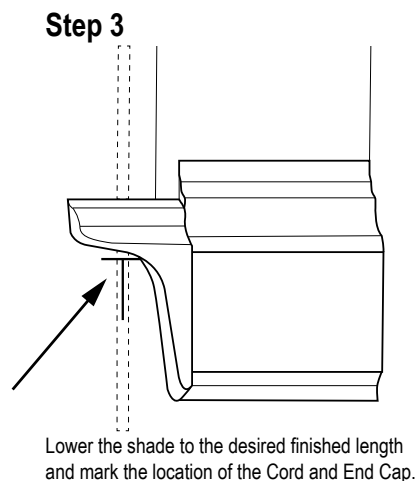
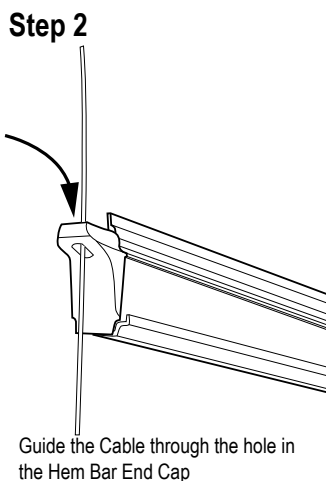
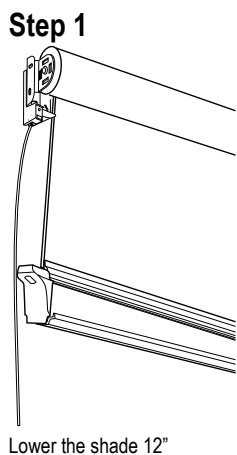

FIGURE B



If shade veers toward the left (Fig. B) lower the shade completely and place a 4" strip of masking tape on the roller on the right side. Repeat as necessary until a straight roll is achieved.

Step 5 Install Cable to the Shade



Repeat the process for both sides of the shade

Step 6 Install Lower Cable Tensioner

Step 1

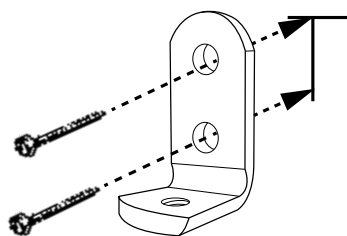

Use the mark you made in the previous step to line up the L bracket and use two screws to attach it to the mounting surface

Step 2

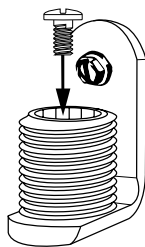

With the L bracket in place use the small screw to attach the Threaded Cable Adjuster

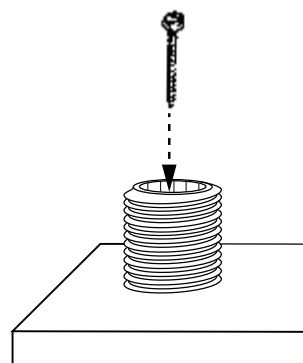

If you are mounting on a window sill or other horizontal mounting surface, attach the Threaded Cable Adjuster to that surface with a screw

Installation Instructions

Step 7 Install Cable into Lower Cable Tensioner

Step 1

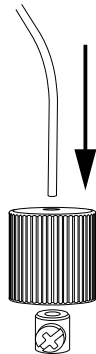

Insert cable through the Threaded Adjustment Cap first, and then the Cable Retainer Sleeve

Step 2

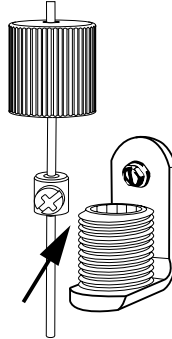

Line up the Cable Retainer Sleeve with the Top of the Threaded Lower Cable Tensioner

Step 3

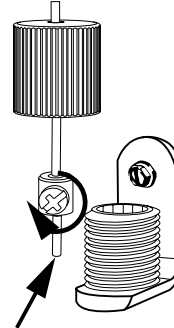

Tighten the set screw on the Cable Retainer Sleeve by turning the locking screw clockwise.
Cut the cable off 1/8" past the sleeve

Step 4

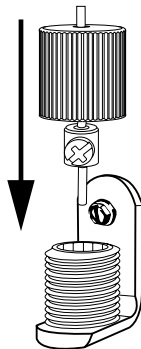

Insert the Cable and Retainer Sleeve into the Threaded Lower Cable Tensioner

Step 5

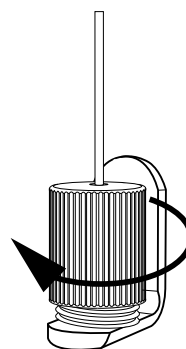

Twist on the Threaded Adjustment Cap and tighten until the cable is taut

Do not Overtighten

Step 8 Chain Stop, Cord Tension Lock

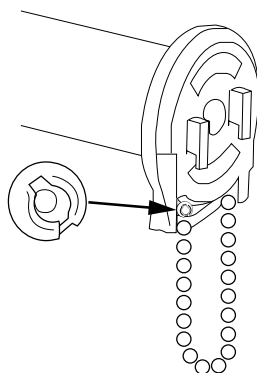

Lower Shade to desired length.

On the front of the chain directly below the clutch, attach the round stop to the first bead on the chain.

This will prevent the shade from being lowered beyond the desired length.

Cord Tension Lock



See Cord Tension Lock installation instructions