

GENESIS®

Installation Instructions

Roman Shades

Thank You

Thank you for choosing your Genesis® shade
With proper installation and care, your new blinds will provide many years of beauty and performance.

Before Installing

Remove blind from the package. Keep all packaging until blind operates to your satisfaction. Contents of your hardware package may vary depending on options chosen.
Additional fasteners may be needed on your specific mounting surface (not included).

Tools Needed



Pencil



Screw Driver



Level



Measuring tape



Drill

Your Shade

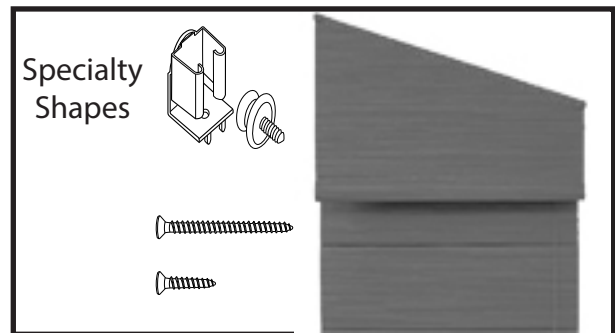
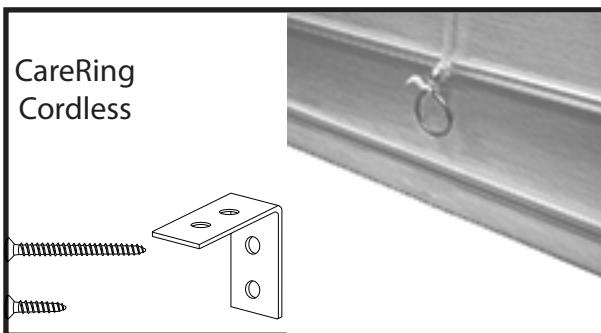
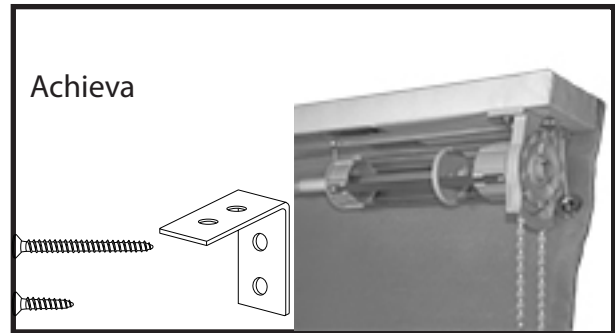
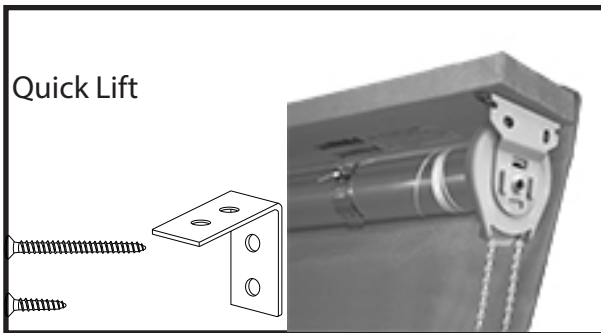

Inside Mount

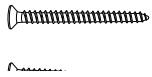

For **Inside Mounts** there are no brackets required

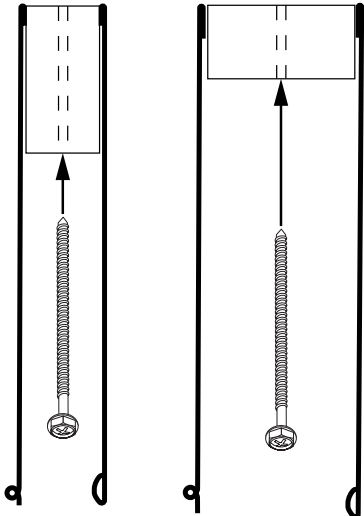

(Hardware removed for clarity)

- Space screw locations evenly on the headrail and pre-drill using an $\frac{1}{8}$ " drill bit
- Make sure that screws are clear of any hardware or moving cords that operate the shade
- Attach headrail to mounting surface using 3" screws

L Brackets

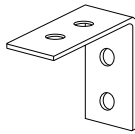

- Measure 2" in from the ends of the headrail
- Make sure that brackets are clear of any hardware or moving cords that operate the shade
- Mark the bracket location on the mounting surface.
- Space any additional brackets evenly on the headrail

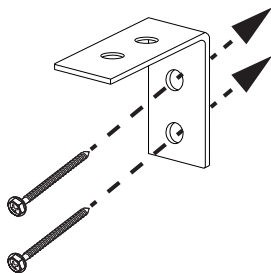

- Mark mounting surface and Pre-drill mounting surface using an $\frac{1}{8}$ " drill bit
- Attach brackets to mounting surface using 2 1/2" screws

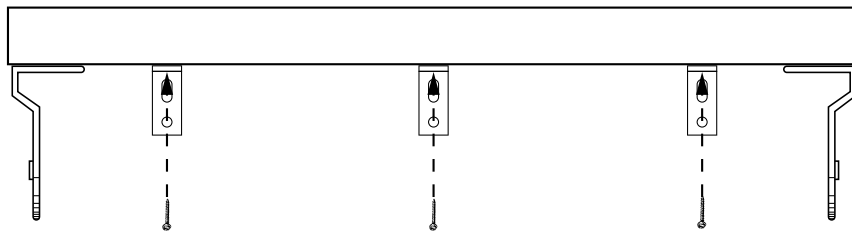

(Hardware and shade removed for clarity)

- With brackets installed use a 1 1/2" screw to attach the headrail

Specialty Shape

Inside Mount Only

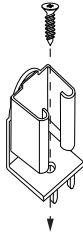

- Space Button Catches evenly across your Specialty Shape and mark mounting surface
- Attach brackets to mounting surface using the screw provided

Step 1

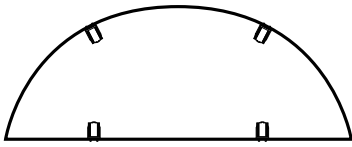

Space Button Catches evenly in window opening

Step 2

(Hardware and shade removed for clarity)

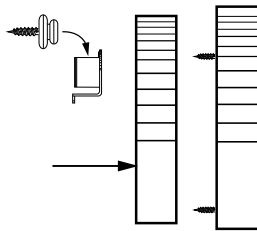

Place Buttons with screws into the Button Catches. Line up your Specialty Shape and press against screws

Step 3

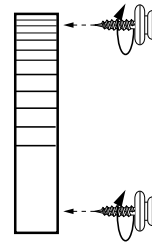

Use the marks that the screws made as a guide to install the Button Screws by turning directly into the Specialty Shape

Step 4

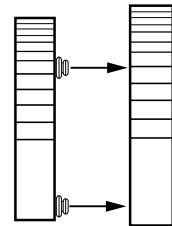

Snap buttons into the button catches in the opening to install the Specialty Shape