

Installation Instructions

SL-Series Clutch and Accu-Rise

Thank You

Thank you for choosing Genesis Custom Window Shades. With proper installation and care, your new shades will provide many years of beauty and performance.

Before Installing

Remove shade from the package. Keep all packaging until shade operates to your satisfaction. Contents of your hardware package may vary depending on options chosen. Additional fasteners may be needed on your specific mounting surface.

Tools

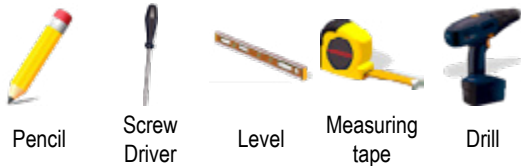

Fasteners

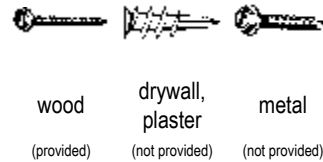

Your Shade

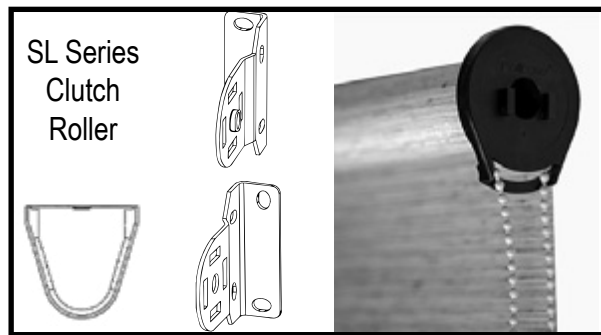

Step 1 Install Brackets

Clutch Installation brackets are universal and can be used for inside, outside, ceiling, and reverse roll mounting.

Attach brackets with screws to window frame, molding, wall, or ceiling. Ensure that brackets are mounted level and flat against mounting surface and not at an angle.

Outside Mount

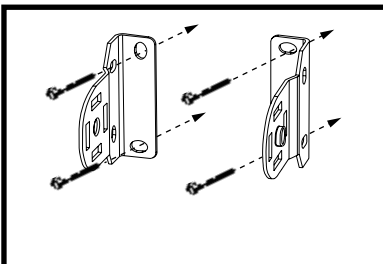

Inside Mount

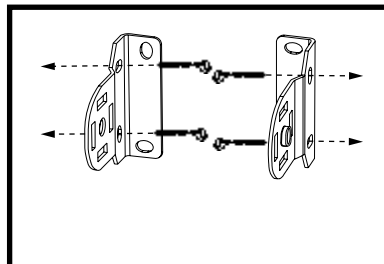

Ceiling Mount

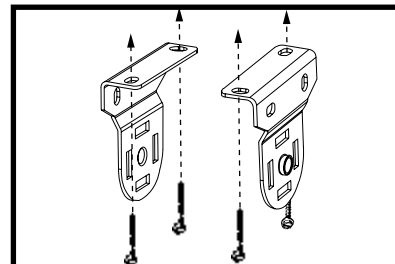

Make sure Brackets are mounted Level or the shade will not roll straight.

Installation Instructions

Step 2

Install the Shade

Make sure that the shades are rolled up to the roller before installation

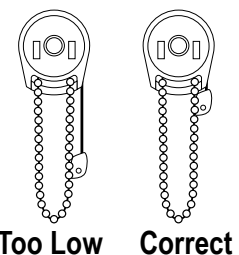

Step 1

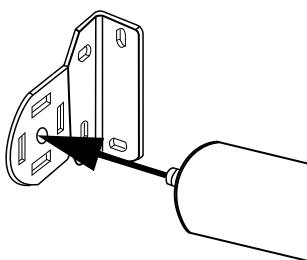

Insert the Spring Loaded Pin end into the round hole in the bracket

Step 2

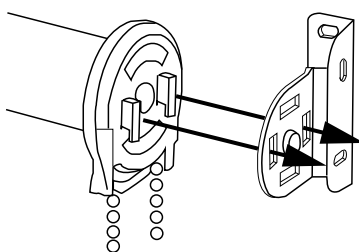

Keeping the pin end in the bracket, insert the Hook Arms on the clutch straight into the receiving slots on the bracket.

The bottom of the clutch should always point down.

Step 3

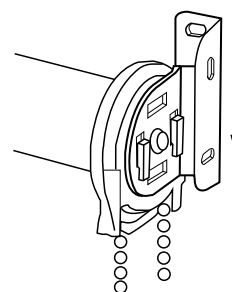

Gently push the hook arms down onto the bracket to lock them in place.

CAUTION: DO NOT remove the retainer pin before shade is fully installed and seated in brackets

Accu-Rise

Remove retainer pin after shade is fully installed and the hook arms are fully seated in the bracket.

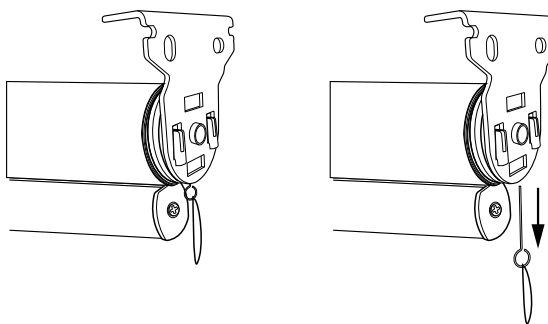

Step 3

Operate the Shade

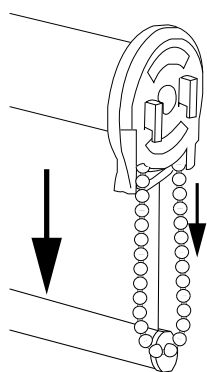

Pull gently on the back side of the chain to to lower it.

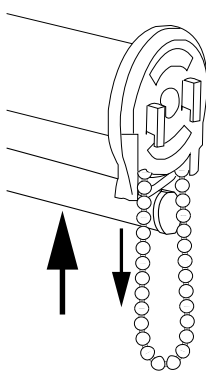

Pull gently on the front side of the chain to to raise it.

Accu-Rise

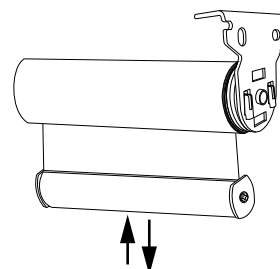

Pull Accu-Rise shade gently from the center of the shade to lower it. Push up from center to raise it.

Check Shade for proper operation. If shade Skews left or right (does not roll up straight), check that the brackets are level. If brackets are level and the shade still skews, it may require shimming.

Installation Instructions

Shimming

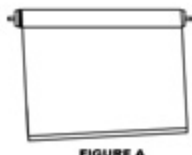
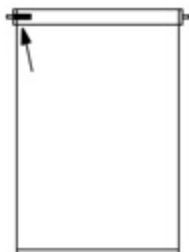

FIGURE A

If shade veers toward the right (Fig. A)

Lower the shade completely and place a 4" strip of masking tape on the roller on the left side. Repeat as necessary until a straight roll is achieved.



FIGURE B

If shade veers toward the left (Fig. B)

Lower the shade completely and place a 4" strip of masking tape on the roller on the right side. Repeat as necessary until a straight roll is achieved.

Step 4

Install Cord Tensioner, Hold Downs, Bracket Covers, Bead Stop

Cord Tension Lock

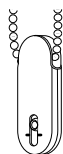

See Cord Tension Lock installation instructions

Hold Downs

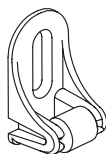

See Hold-Down installation instructions

Bracket Covers

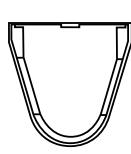

Slide Bracket Covers over the installation brackets until snapped into place.

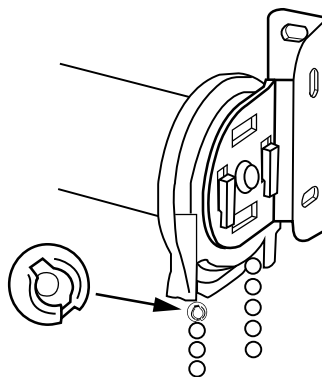
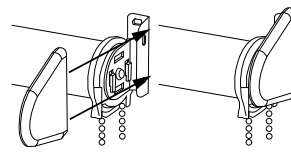

Lower Shade to desired length.

On the front of the chain directly below the clutch, attach the round stop to the first bead on the chain.

This will prevent the shade from being lowered beyond the desired length.